

# VHD-J1600SE

## DATASHEET - MANUAL



### MAIN FEATURES

- H.265 Support encoding, enabling full HD 1080p/60fps video stream by ultra-low bandwidth, lag-time within 200ms.
- 1080P Full HD Apply Panasonic's 1/2.7 inch, 2.07 million effective pixels high quality HD CMOS sensor, can reach maximum 1920x1080 high resolution and achieve quality image.
- Double Interface Support 3G-SDI interface, effective transmission distance up to 150 meters (1080p30). SDI, Network can output at the same time.
- Ultra-high Frame Rate The output frame rate up to 60fps in 1080P, up to 120fps output in 720P (supported by network only), 640x480P can be as high as 240fps (supported by network only, optional).
- AAC Audio Encoding audio encoding, better sound quality and smaller bandwidth.
- Low-light High SNR of CMOS sensor combined with 2D and 3D noise reduction algorithm, effectively reduce the noise, even under low illumination conditions, picture can still keep clean and clear.
- PoE Support (802.3af), effectively reduce the cost of engineering and routing.
- ICR Infrared Filter with auto switch, keep watch over day and night.
- SDK Support, easy to implement the custom requirement.

## CAMERA

VIDEO SYSTEM	1080P/60, 1080P/50, 1080I/60, 1080I/50, 1080P/30, 1080P/25, 720P/120 (SUPPORTED BY NETWORK ONLY), 720P/60, 720P/50, 720P/30, 720P/25, 640X480P/240 (SUPPORTED BY NETWORK ONLY, OPTIONAL)
SENSOR	1/2.7", CMOS, EFFECTIVE PIXEL: 2.07M
SCANNING MODE	PROGRESSIVE
LENS MOUNT	C/CS MOUNT
AUTO IRIS	DC DRIVER
MINIMAL ILLUMINATION	0.05 LUX @ (F1.8, AGC ON)
SHUTTER	1/30S ~ 1/10000S
WHITE BALANCE	AUTO, 3000K/INDOOR, 4000K, 5000K/OUTDOOR, 6500K_1, 6500K_2, 6500K_3, ONE PUSH, MANUAL
DAY-NIGHT MODE	IR CUT FILTER WITH AUTO SWITCH
DIGITAL NOISEREDUCTION	2D,3D DIGITAL NOISE REDUCTION
BACKLIGHTCOMPENSATION	SUPPORT
IMAGE FREEZE	SUPPORT
POE	SUPPORT
CEILING INSTALLATION	SUPPORT

## INPUT/OUTPUT INTERFACE

HD OUTPUT	1X3G-SDI: BNC TYPE, 800MVP-P, 75Ω, ALONG TO SMPTE 424M STANDARD
NETWORK INTERFACE	1XRJ45:10M/100M ADAPTIVE ETHERNET PORTS
AUDIO INTERFACE	1-CH: 3.5MM AUDIO INTERFACE, LINE IN
POWER CONNECTOR	JEITA (DC IN 12V)
RESET BUTTON	SUPPORT

## IPC FEATURES

VIDEO COMPRESSION	H.265/H.264/MJPEG
VIDEO STREAM	MAIN STREAM, SUB STREAM
MAIN STREAMRESOLUTION	1920X1080, 1280X720, 1024X576
SUB STREAMRESOLUTION	720X576, 720X480, 320X240
VIDEO BIT RATE	128KBPS ~ 8192KBPS
BIT RATE TYPE	VARIABLE RATE, FIXED RATE
FRAME RATE	50HZ: 1FPS ~ 50FPS, 60HZ: 1FPS ~ 60FPS, 720P120: 120FPS, 640X480P240: 240FP
AUDIO COMPRESSION	AAC
AUDIO BIT RATE	96KBPS, 128KBPS, 256KBPS
SUPPORT PROTOCOLS	TCP/IP, HTTP, RTSP, RTMP, ONVIF, DHCP, MULTICAST, ETC.

## GENERIC SPECIFICATION

INPUT VOLTAGE	DC 12V / POE (802.3AF)
CURRENT CONSUMPTION	0.5A (MAX)
OPERATINGTEMPERATURE	-10°C ~ 40°C (14°F ~ 104°F)
STORAGE TEMPERATURE	-40°C ~ 60°C (-40°F ~ 140°F)
POWER CONSUMPTION	6W (MAX)
SIZE	127.5MM X 72.0MM X 60.0MM
NET WEIGHT	375G (0.8LB)
MTBF	6000H

## APPEARANCE AND INTERFACE

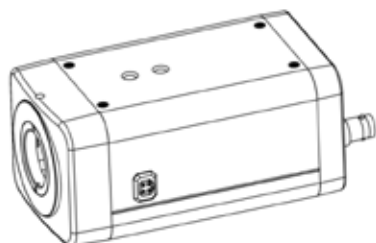

### > PACKING LIST

When opened the package, please check and confirm that all attachments shall be provided:

HD Color Box Camera	X1
The user manual	X1
Certificate/warranty card	X1

### > NOTES

#### ELECTRIC SAFETY

installation and operation must accord with electric safety standard.

#### CAUTION TO TRANSPORT

avoid stress, vibration and soakage in transport, storage and installation.

#### POLARITY OF POWER SUPPLY

the power supply of the product is +12v, the max electrical current is 2a. Polarity of the power supply plug drawing as follows.

#### CAREFUL OF INSTALLATION

Do not grasp the camera head when carrying the camera. Don't turn camera head by hand. Doing so may result in mechanical damage. Never power on before installation is not completed.

#### DON'T DISMANTLE THE CAMERA

We are not responsible for any unauthorized modification or dismantling.

#### **CAUTION!**

The specific frequency of electromagnetic field may affect the image of the camera!

### > MAIN FEATURES

#### H.265 SUPPORT

Support H.265 encoding, enabling full HD 1080p/60fps video stream by ultra-low bandwidth, lag-time within 200ms.

#### 1080P FULL HD

Apply Panasonic's 1/2.7 inch, 2.07 million effective pixels high quality HD CMOS sensor, can reach maximum 1920 x 1080 high resolution and achieve quality image.

#### DOUBLE INTERFACE

Support 3G-SDI interface, effective transmission distance up to 150 meters (under 1080p30). SDI, Network can output at the same time.

#### ULTRA-HIGH FRAME RATE

The output frame rate up to 60fps in 1080P.

#### AAC AUDIO ENCODING

Support AAC audio encoding, better sound quality and smaller bandwidth.

#### LOW-LIGHT

High SNR of CMOS sensor combined with 2D and 3D noise reduction algorithm, effectively reduce the noise, even under low illumination conditions, picture can still keep clean and clear.

#### POE (OPTIONAL)

Support PoE (802.3af), effectively reduce the cost of engineering and routing.

#### ICR INFRARED FILTER

ICR filter with auto switch, keep watch over day and night.

#### SDK

Support SDK, easy to implement the custom requirement .

## > CAMERA DESCRIPTION

### CAMERA APPEARANCE

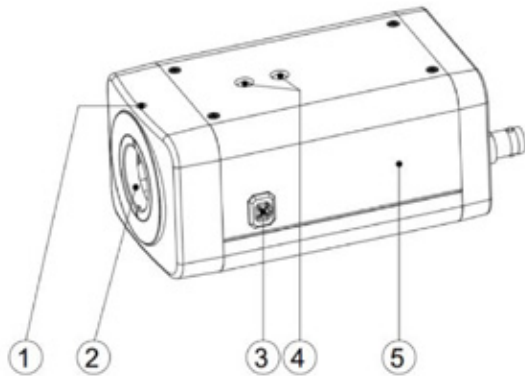

1. Lens focal adjustment after fixed screw holes.
2. Lens mounting position (only for C / CS lens \*).
3. Aperture control interface (only applicable CD automatic aperture).
4. The installation location hole.
5. Fuselage.

Both sides threaded hole is consistent with the positioning hole size, installation can be used instead of each other.

### NOTICE!

Use C camera lens, you need to use special adapter ring.

### THE BACK OF THE INTERFACE SPECIFICATIONS

1. DC 12V power interface
2. Power light
3. Six spring terminals:

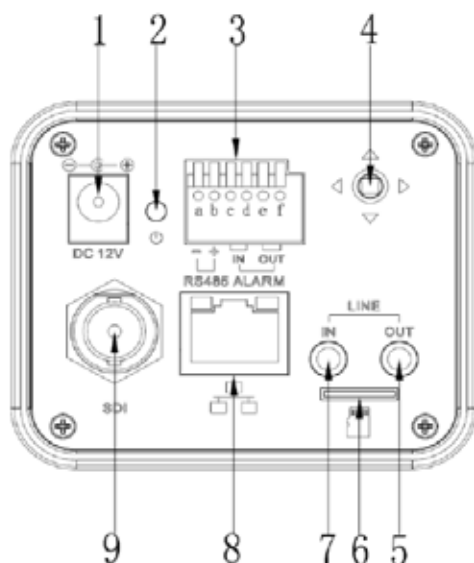

Specific function shown in the table below:

Serial number	function
a	RS 485-
b	RS 485+
c	Alarm in put 1
d	Alarm in put 2
e	Alarm output 1
f	Alarm output 2

4. MENU key  
Move MENU key up and down or so, in order to select the MENU options. Press down for selected.
5. LINE OUT key
6. CF Card
7. LINE IN key
8. Internet port
9. 3G-SDI interface

### OPERATING TIPS!

Press "MENU" button and then to electricity and keep holding down the "MENU" button 8 seconds, the camera will restore factory Settings.

## > OSD MENU OPERATION

### KEY DESCRIPTION

The camera uses one buttons, around the menu button, logo (▲▼) up and down, logo (◀▶) left and right; Under normal image press "MENU" key, the screen displays the main menu, toggle (▲▼), from top to bottom cycle options menu item and press select menu options, use a scroll arrow or highlight the selected item, press menu button to highlight the menu item; Each menu page has a "Return" option, to Return to the superior menu or exit the menu.

### MENU (Main Menu)

Directly press "MENU" button to enter the main menu.

### MENU

- ▶ Exposure
- ▶ Color
- ▶ Image
- ▶ Noise Reduction
- ▶ Setting
- ▶ Information
- ▶ Restore Default
- ▶ Exit

### OPERATING TIPS

Press "MENU" button and then to electricity and keep holding down the "MENU" button 8 seconds, the camera will restore factory Settings.

### OSD MENU OPERATION

Toggle the buttons up and down (▲▼) Choose a menu item, press MENU to enter sub MENU. Choose [Exit] press MENU button to exit menu.

### EXPOSURE

- ▶ Mode Full Auto
- ▶ ExpCompMod On
- ▶ ExpComp -1
- ▶ Gain Limit 3
- ▶ Backlight Off
- ▶ DRC Strength 3
- ▶ Anti Flicker 50Hz
- ▶ Style Manual Return

### OPERATING TIPS

Mode: Set the camera exposure mode.

Optional items: Full Auto, Bright, Shutter Priority.

Shutter: Set the Shutter values, only when the Mode for the Shutter Priority Mode and Manual Mode effective, Optional items: 1/10000s,1/6000s,1/4000s,1/3000s,1/2000s,1/1500s,1/1000s,1/725s,1/500s,1/350s,1/250s,1/200s,1/125s,1/100s,1/90s,1/60s,1/30s.

GainLimit: Set the Gain value, Optional items: 0~15.

Bright: Set the brightness values, only when the effective Mode for Bright Mode, Optional items: 0~17.

ExpCompMode: Set the exposure compensation mode, can be installed: On, Off.

ExpComp: Set the exposure compensation value, only when ExpCompMode item to On effective, Optional items: -7~7.

Backlight: Set the backlight compensation, Optional items: On, Off.

DRC Strength: Set up digital wide dynamic strength, can set up different levels of wide dynamic effect, Optional items: 0~8.

Anti Flicker: Set the flashing function, Optional items: 50Hz, 60Hz, Off.

Style: Optional items: Manual, DC.

Return: get back

### COLOR

- ▶ WB Mode Auto
- ▶ AWB sens Low
- ▶ RG Tuning 2
- ▶ BG Tuning -1
- ▶ Saturation 100%
- ▶ Hue 7
- ▶ Return

### OPERATING TIPS

Luminance: Brightness adjustment.

Optional items: 0~14.

Contrast: Contrast adjustment.

Optional items: 0~14.

Sharpness: Sharpness adjustment.

Optional items: Auto, 0~15.

Flip-H: Image flipped horizontally.

Optional items: On, Off.

Flip-V: Image Flip Vertical.

Optional items: On, Off.

Gamma: Gamma adjustOptional items:

Default, 0.45, 0.5, 0.56, 0.63.

Style: Optional items: Norma, Clarity, Bright, Soft.

LDC: Optional items: Off, 1-10.

Return: get back.

### NOISE REDUCTION

▶ 2D NR 3

▶ 3D NR 3

▶ RETURN

### OPERATING TIPS

2D NR: 2D noise reduction,

Optional items: 1 ~ 5, Close, Auto.

3D NR: 3D noise reduction,

Optional items: 1 ~ 8, Close.

Return: get back.

### SETTING

▶ LANGUAGE ENGLISH

▶ PROTOCOL VISCA

▶ VISCA ADDRESS 1

▶ BAUDRATE 9600

▶ VIDEO FORMAT 1080P30

▶ EPTZ OFF

▶ RETURN

### OPERATING TIPS

Language: Language Settings.

Optional items: English, Chinese.

Protocol: Communication protocol Settings.

Optional items: VISCA, PELCO-D, PELCO-P.

VISCA Address: Address of the Visca.

Settings, Optional items: 0~7.

P-D Address: P-D address settings, valid in PELCO-D.

Optional items: 0~254.

P-P Address: P-P address settings, valid in PELCO-P.

Optional items: 0~31.

Baudrate: Camera baud rate settings,  
 Optional items: 38400,19200,9600,4800,2400.  
 Video Format: Camera video format settings,  
 Optional items: 1080I50, 1080I60,1080P60,  
 1080P50, 1080P30, 1080P25, 720P60, 720P50.  
 EPTZ: Optional items: Off. Return: get back.

## INFORMATION

- ▶ VERION 7.1.79
- ▶ DATA 2016-01-15
- ▶ IP 192.168.100.99
- ▶ GATEWAY 192.168.100.1
- ▶ NETMASK 255.255.255.0
- ▶ RETURN

## RESTORE FACTORY SETTINGS

- ▶ YES
- ▶ NO
- ▶ RETURN

## OPERATING TIPS

YES: verify, press MENU to restore factory Settings.  
 NO: cancel, press MENU to back to menu.  
 RETURN: get back.

## > EQUIPMENT SETUP AND INTERNET CONNECTION

### 1. OPERATING ENVIRONMENT

Operating System: Windows 2000/2003 /XP/vista/7/8.

Network Protocol: TCP/IP.

Client PC: P4/128MRAM/40GHD support scaled graphics card, support DirectX8.0 or more advanced version.

### 2. EQUIPMENT INSTALLATION

- 1) Connect internet camera to your internet or to your PC directly via internet cable.
- 2) Turn on DC12V power.
- 3) The orange light of internet port lit on, green light flashing, and the physical connection finished.

### 3 INTERNET CONNECTION

Connection ways between internet camera and computer, as picture 1.1 and picture 1.2 shown:

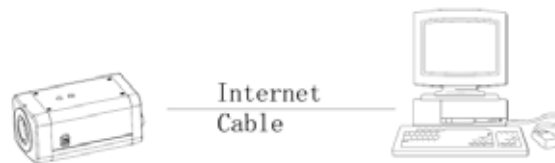

Picture 1.1 connect by ethernet cable.



Picture 1.2 Connect by router /interchanger.

## > IP CAMERA VISITED/ CONTROLLED BY LAN

### > SETUP IP ADDRESS

IP camera default IP address"192.168.100.

88", Unknow camera IP, view as below:

Method 1: connect camera to TV,press [menu] of the behind camera, select "Information", the camera IP will be show on screen.

Method 2: connect camera to PC with ethernet cable, use "upgrade\_En.exe" to search for IP address.

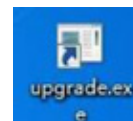

Change IP address, 2 methods as below:

Method 1: On web control page, find "Network"

---->Change IP

---->Click "Apply"

----> Restart camera.



Method 2: Open "upgrade\_En.exe", change IP and click "Set".

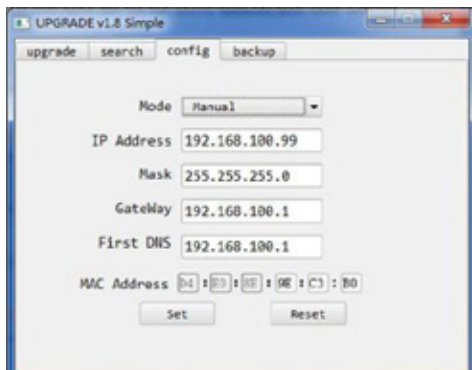

**NOTE!**

IP camera default IP address "192.168.100.88", user "admin", password "admin". After modified, IP Camera be restart.

**NOTE!**

If user first time use this camera by internet (only for new user), must install a player software (VLC). Please go to VLC website: <http://www.videolan.org/vlc>, download and Install VLC (player software). After installation, login again, will show as above:

**> VISIT/ACCESS IP CAMERA**

Input <http://192.168.100> to IE ( better with IE web browser, others will cause little latency), a login window pop up, input login name: admin, password: admin, shown as below:



After login shown as below:

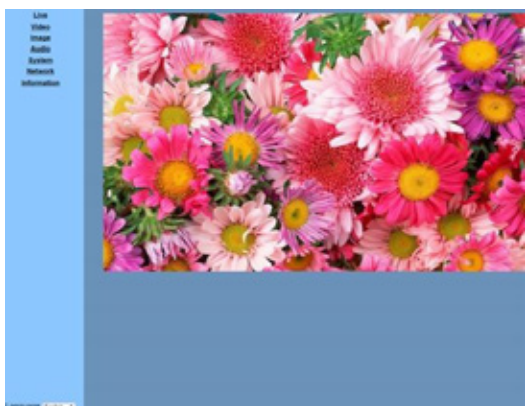

**> IP CAMERA ACCESSED/ CONTROLLED BY WAN (internet)**  
**> SETUP IPC ACCESSED/ CONTROLLED BY DYNAMIC DNS**

2 DYNAMIC DNS AVAILABLE:

Dyndns.org, 3322.org.

ROUTER PORT MAPPING:

Take TP-LINK router for example, enter Router Home Page (interface page), select "Transit control"- "Transit rule"--"Virtual server"-- "Virtual service", add a new port number in "Outside Port", add a new port number in "inside port", put camera IP address to "IP address", then select "Apply" and "Add", shown as below: (sorry, we do not have English Version TP-Link here, so put the Chinese Version picture for reference, the position is the same).



**> DYNAMIC DNS VISIT CAMERA**

Set domain name to camera, setup the parameter, then dynamic DNS can access camera. Access link: <http://hostname: port number> For example, setup host computer name: youdomain.f3322.org, camera port number: 554, Access link should be: <http://youdomain.3322.org:554>.



**NOTE!**

If camera port default as 80, then unnecessary to input port number, use host name can access camera directly.

**> VLC STREAM MEDIA PLAYER MONITORING VISIT VLC MEDIA SERVER PROCEDURE**

Open VLC media player, click "Media"->"Open Network Steam", or click "Ctrl+N"; as below:

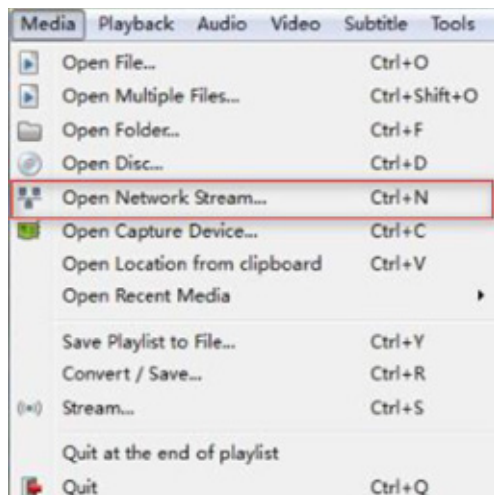

Input URL address:  
 rtsp://ip: port number/1 (Main stream);  
 rtsp://ip: port number/2 (Sub stream).

**NOTE!**

RTSP port number default value is 554.

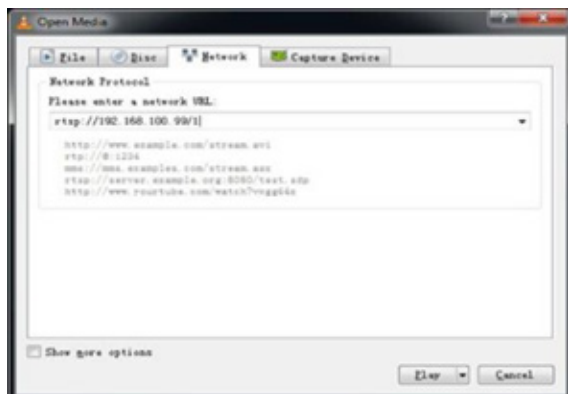

**> IP CAMERA PARAMETER SETUP**

Homepage Introduction

Menu

All pages include 2 menu bars:

Real time monitoring: displaying video image

Parameter setup: with function buttons.

Video Viewing Window

Video viewing window must be same as video resolution, the bigger the resolution is, the bigger the playing area is.

Double click viewing window, will show full-screen, double click again, will return to initialized size.

Status bar in viewing window shown as below:



1) Video playback pause button: control real-time video pause, stop the last picture, click recoverable video again.

2) Audio control buttons: can set silent mode.

3) Full screen switch button.

Language Selection

CHINESE/ENGLISH/RUSSIAN

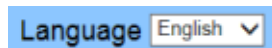

**> MEDIA**

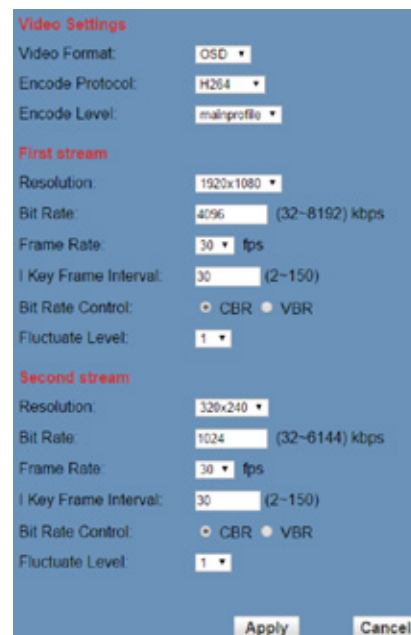

## 1) VIDEO FORMAT

Support 50HZ and 60HZ, and OSD three formats.

## 2) ENCODE PROTOCOL

Support H.264 and H.265 and MJPEG three formats.

## 3) ENCODE LEVEL

Support baseline, mainprofile, highprofile three formats.

## 4) RESOLUTION

Main bit flow support 1920x1080,1280x720, 1024x576 minor bit flow support 720x480, 720x576, 320x240, the bigger resolution is, the clearer the image will be, more network bandwidth will be taken.

## 5) BIT RATE

User can assign bit flow/stream, normally speaking, the bigger bit flow is, the clearer the image will be. The bit allocation must combine with network bandwidth, when the network.

## 8) BIT RATE CONTROL

Code stream control way:

Constant bit rate: video coder will be coding according to preset speed.

Variable bit rate: video coder will adjust the speed based on preset speed to gain the best image quality.

## 9) FLUCTUATE LEVEL

Restrain the fluctuation magnitude of variable rate, grade 1~6 bandwidth is too narrow and the allocated bit flow is too big, will cause video signal flow not to be transmitted normally, the video effect will be worse.

## 6) FRAME RATE

User can specify the size of the frame rate, generally, the frame rate greater, the image more smooth; Frame rate is smaller, the more sense of beating.

## 7) I KEY FRAME INTERVAL

Set interval between 2 I frame, the bigger interval is, the response will be lower from viewing window.

## 8) BIT RATE CONTROL

Code stream control way: constant bit rate video coder will be coding according to preset speed. Variable bit rate video coder will adjust the speed based on preset speed to gain the best image quality.

## 9) FLUCTUATE LEVEL

Restrain the fluctuation magnitude of variable rate, grade 1~6.

## > SYSTEM SETTING, PLEASE CLICK "SYSTEM"

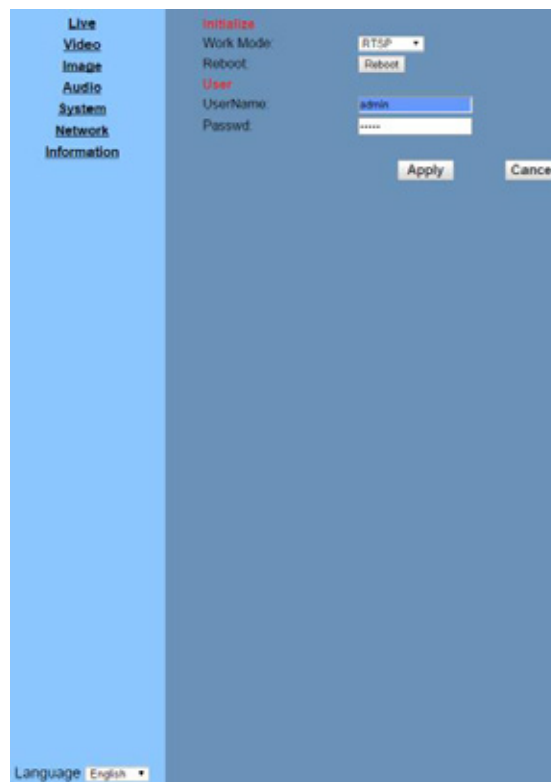

## 1) WORK MODE

Work Mode RTSP.

## 2) REBOOT

Click the "Reboot" button, system restart.

## 3) USER AND PASSWORD.

The user can modify the password (letters and Numbers only).

## 4) APPLY / CANCEL

Modify password and click the "apply" button to the login page, press "cancel" button to cancel password change.

## > NETWORK SETTING, PLEASE CLICK "NETWORK"

"NETWORK"



### 1) LAN SETTINGS

Default the IP address is 192.168.100.88,

The MAC address can be modified.

### 2) PORT SETTINGS

A. HTTP Port:

IP address identifies the network device, the device can run multiple web applications, each network program using network port to transmit data, so data transmission to be carried out between the port and port. Port setting is to set up WEB SERVER program using which port to transmit. When port mapping, need to be consistent with the port number (default port: 80).

B. RTSP Port:

Network camera support RTSP protocol, use the VLC tools broadcast.

C. PTZ Port:

Support PTZ protocol, default port: 5678.

### 3) CONTROL PROTOCOL SETTING

Setting camera control communication protocol, include Visca address, Pelco-D address, Pelco-P address.

### 4) RTMP Setting

Setting the camera stream, can set up two stream, in the two stream selection control code stream of "On", "Off", "Video", "Audio", etc.

### 5) RTSP Setting

Setting network camera rtsp protocol of "On", "Off".

### 6) ONVIF Setting

Setting the ONVIF protocol and ONVIF authorization "On", "Off".

### 7) MULTICAST SETTING

Setting multicast "On", "Off", and multicast address (default address 224.1.2.3) and port (default 6688).

### 8) APPLY / CANCEL

Modify network parameters then press "Apply"

button to modify network parameters, press "Cancel" button to cancel network parameters.

6.5 Device Information, please click "information"

Show the current device information, as shown below.

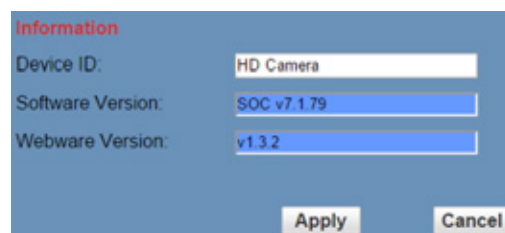

## > DOWNLOAD THE NETWORK UPGRADE PROGRAM

If you need the camera upgrade program, please contact the manufacturer.

## > MAINTENANCE AND TROUBLESHOOTING

### MAINTENANCE OF THE CAMERA

If the camera is not used for a long time, after use, please disconnect the power switch, at the same time the ac power adapter and ac socket to disconnect. Clear the dust on the camera housing, please use soft cloth or cotton paper.

Clean the camera lens, please use dry soft cloth to wipe, such as dirt serious when, please use neutral detergent wipe gently.

Don't use strong or with corrosive cleaner, so as to avoid the lens scratches, influence the image effect.

## > MAINTENANCE AND TROUBLESHOOTING

- BEYOND THE CAMERA WORK INTENSITY OF ILLUMINATION

Camera may be more than camera work intensity of illumination, the image cannot achieve the best effect.

- THE CAMERA SHOULD AVOID USING AT THE FOLLOWING SPECIFIC SITUATION

Camera should avoid shooting especially bright objects, such as sunshine, lamplight, etc.

The camera don't work in lighting conditions unstable environment, otherwise the image will happen.

Don't can launch a large power of the facilities around the use of radio waves, such as television or radio transmitters, etc.

## > FAULT PHENOMENON AND PROCESSING

- IMAGES

Display shows no image:

- 1) Check whether the camera power supply is connected and the voltage is normal, whether the power light shine.
- 2) Check whether video platform, TV cable connection is normal .
- 3) Check for manual lens aperture and open the aperture.

Sometimes there is no image:

- 1) Check whether video platform, TV cable connection is normal.
- 2) Check whether the camera installation safety, if there is a strong shock.

Image blurring:

- 1) Check whether the lens focusing accurately.
- 2) Check whether the lens surface is clean.

- CONTROL

Serial port can't control:

- 1) The camera control parameters is set up correctly.
- 2) Check whether control line connection is good.

## > STANDARD SPECIFICATION

MODEL NAME	VHD-J1600SE HD COLOR BOX
<b>CAMERA</b> VIDEO SYSTEM	1080P/60, 1080P/50, 1080I/60, 1080I/50, 1080P/30, 1080P/25, 720P/60, 720P/50
SENSOR	1/2.7", CMOS, EFFECTIVE PIXEL: 2.07M
SCANNING MODE	PROGRESSIVE
LENS MOUNT	C/CS MOUNT
AUTO IRIS	DC DRIVER
MINIMAL ILLUMINATION	0.05 LUX @ (F1.8, AGC ON)
SHUTTER	1/30S ~ 1/10000S
WHITE BALANCE	AUTO, 3000K/INDOOR, 4000K, 5000K/OUTDOOR, 6500K_1, 6500K_2, 6500K_3, ONE PUSH, MANUAL
DAY-NIGHT MODE	IR CUT FILTER WITH AUTO SWITCH
DIGITAL NOISE REDUCTION	2D,3D DIGITAL NOISE REDUCTION
BACKLIGHT COMPENSATION	SUPPORT
PoE	SUPPORT
CEILING	SUPPORT

IPC VIDEO FEATURES	
VIDEO COMPRESSION	H.265/H.264/MJPEG
VIDEO STREAM	MAIN STREAM, SUB STREAM
MAIN STREAM RESOLUTION	1920X1080, 1280X720, 1024X576
SUB STREAM RESOLUTION	720X576, 720X480, 320X240
VIDEO BIT RATE	128KBPS ~ 8192KBPS
BIT RATE TYPE	VARIABLE RATE, FIXED RATE
FRAME RATE	50HZ: 1FPS ~ 50FPS, 60HZ: 1FPS ~ 60FPS
AUDIO COMPRESSION	AAC
AUDIO BIT RATE	96KBPS, 128KBPS, 256KBPS
SUPPORT PROTOCOLS	TCP/IP, HTTP, RTSP, RTMP, ONVIF, DHCP, MULTICAST

INPUT/OUTPUT INTERFACE	
HD OUTPUT	1X3G-SDI: BNC TYPE, 800MVP-P, 75Ω, ALONG TO SMPTE 424M STANDAR
NETWORK INTERFACE	1XRJ45:10M/100M ADAPTIVE ETHERNET PORTS
AUDIO INTERFACE	1-CH: 3.5MM AUDIO INTERFACE, LINE IN
POWER CONNECTOR	JEITA (DC IN 12V)
RESET BUTTON	SUPPORT

GENERIC SPECIFICATION	
INPUT VOLTAGE	DC 12V / POE (802.3AF)
CURRENT CONSUMPTION	0.5A (MAX)
OPERATING TEMPERATURE	-10°C ~ 40°C (14°F ~ 104°F)
STORAGE TEMPERATURE	-40°C ~ 60°C (-40°F ~ 140°F)
POWER CONSUMPTION	6W (MAX)
SIZE	127.5MM X 72.0MM X 60.0MM
NET WEIGHT	375G (0.8LB)
MTBF	6000H

\*Only network coding support.

## > DIMENSION

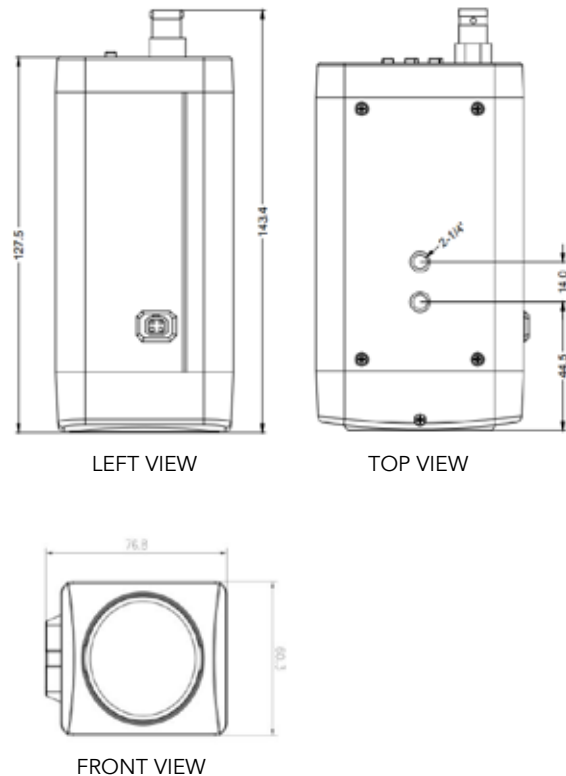

## > COPYRIGHT NOTICE

All contents of this manual, whose copyright belongs to our Corporation. Cannot be cloned, copied or translated without the permission of the company. Product specifications and information which were referred to in this document are for reference only, and the content will be updated at any time without prior notice. All rights reserved, infringement.